

2807-U5A -  
Portaimpronta non forati in acciaio inox - PERMA-LOCK  
ANATOMIC / Non-perforated stainless steel impression  
trays - PERMA-LOCK anatomic

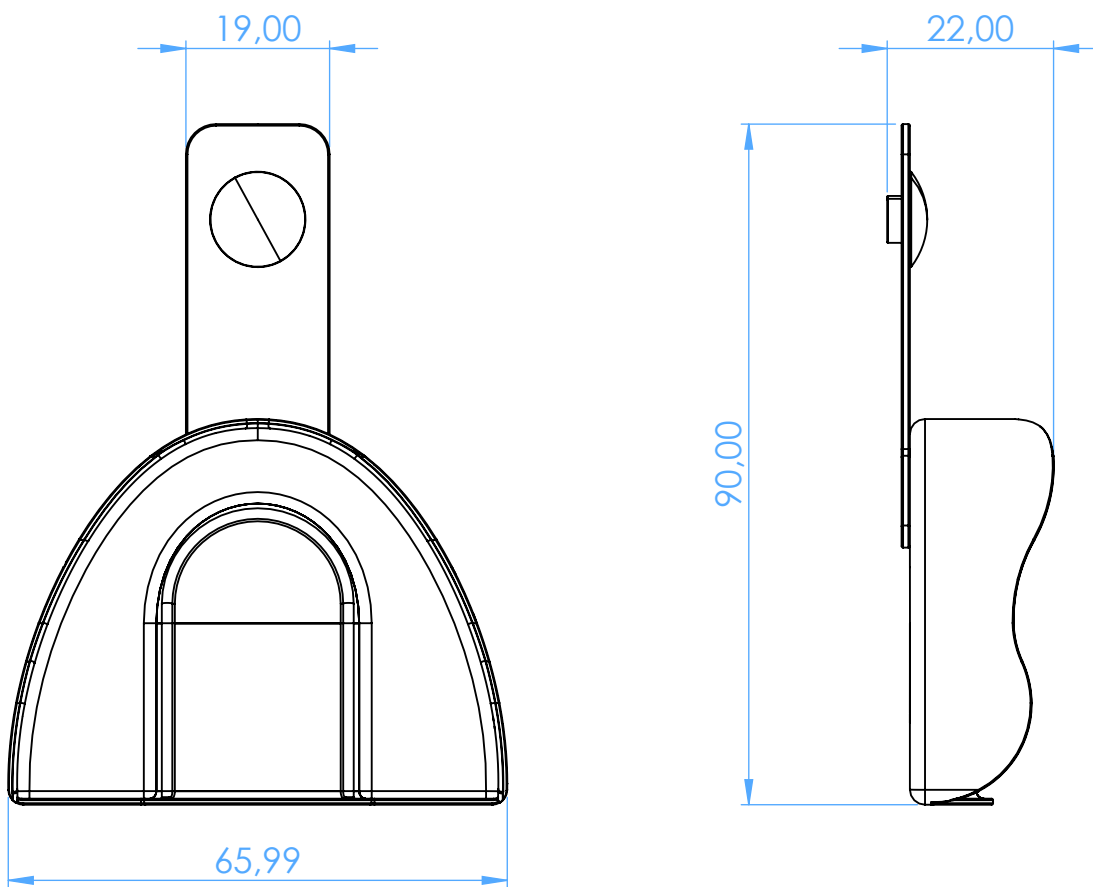

SCALE 1:1