

2813-L4 -  
Portaimpronta forati in acciaio inox - edentuli /  
Perforated stainless steel impression trays - edentulous

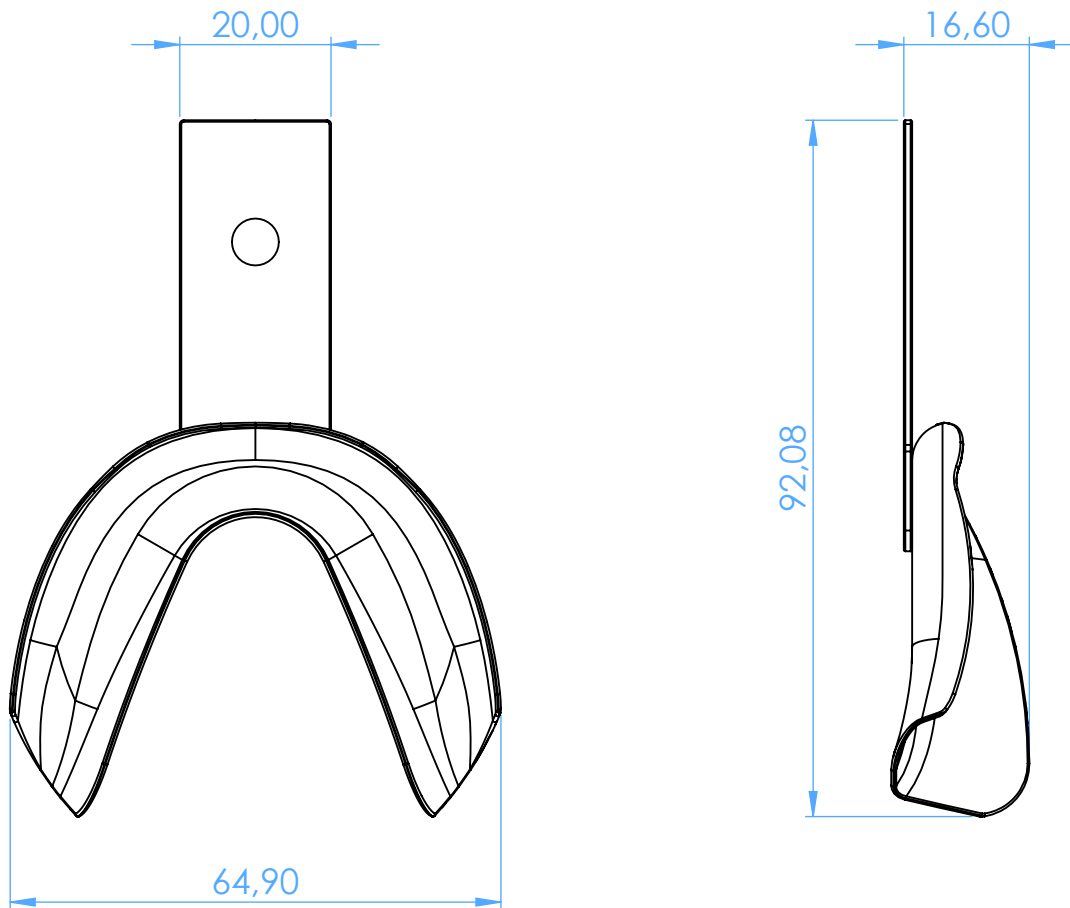

SCALE 1:1